

WHITE
PAPER

THE UPS FOR DATA CENTERS

AND THE MAIN FEATURES IT HAS TO GUARANTEE



The technologies and applications of Data Center are in fast and continuous evolution and the needs of Business Continuity is evolving as well becoming more and more essential.

This White Paper describes the current needs and peculiarities of modern Data Centers and how the state of art of UPS can satisfy them.

LEGAL INFORMATION

Presentation pictures do not always include Personal Protective Equipment (PPE), but this is a legal and regulatory obligation that must be scrupulously respected.

In accordance with its continuous improvement policy, Legrand reserves the right to change the specifications and illustrations without notice. All illustrations, descriptions and technical information included in this document are provided as indications and cannot be held against Legrand.

TABLE OF CONTENTS

INTRODUCTION	4
CONTINUITY.....	5
Availability.....	6
Mean time to repair	8
N+1 redundancy	8
Hot swap.....	9
Legrand UPS and Business Continuity.....	9
TOTAL COST OF OWNERSHIP	11
Total Cost of Ownership: definition	11
Energy efficiency.....	12
Maintenance and servicing.....	13
Advanced battery management	13
Component lifetime	14
Serviceability	14
ADAPTABILITY.....	15
Adaptability with the load	15
Adaptability with electrical infrastructure	18
Adaptability to the room and building.....	19
Adaptability to the application and user.....	21
CONCLUSION	23

INTRODUCTION

Compared to some decades ago, Digital Services are indispensable in daily life of the modern society. Public Administration, Health, Finance, Telecommunications, Commerce, Industry, Entertainment and many other sectors are deeply dependent and empowered by digital services, devices and infrastructures.

Data Centers are the hidden core behind our daily “digital life” which allows us to use and receive digital services. Down time of Data Center means down time of digital service with consequence interruption of activities in the society, problems for people and companies, huge money losses and, sometimes, even dangerous situations.

For this reason, in modern Data Centers, dedicated infrastructures are implemented in order to guarantee the continuity of the operation and to provide high resilience of the system; UPS is one of the essential components in such protecting infrastructure.



All the characteristics and functions which make a UPS suitable with modern Data Center can be easily grouped in three main features:

- Business continuity
- Limited TCO (Total Cost of Ownership)
- Adaptability

Business continuity is strictly related to the reliability of the UPS with high quality material and design. It can be achieved also with advanced monitoring and diagnostic, proper maintenance plan. In addition, the business continuity is surely achieved with redundant configurations and decentralized architectures.

Limited cost of ownership that can be reached with compact footprint, easy service and high efficiency to reduce the energy consumptions.

Adaptability can be reached through scalability, modularity, and with flexibility in the installation of the whole system. Adaptability is related also to electric and energetic performances which make the UPS able to run in best conditions also with load variations or different electric systems.

CONTINUITY

Investing in a UPS system is worth whenever the UPS TCO is lower than the overall costs associated with business interruption. Continuity is therefore paramount in Data Centers, since even the shortest operations breakdown would mean huge losses in terms of not processed or “lost” data and hardware permanent damage. Minor mains disturbances, such as voltage sags and swells, micro-interruptions and flickers, can cause severe damage to data and servers in the long term, as well, with consequent breakdowns for failures and repairs.

How UPS improves continuity:

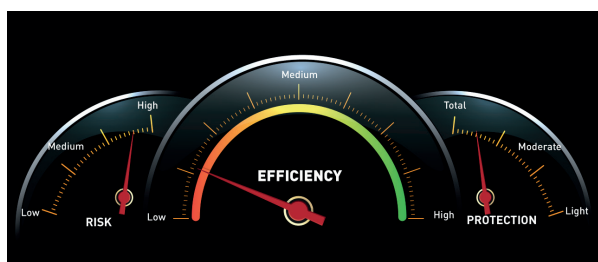

Installing a UPS system in a power supply line greatly helps business continuity by filtering mains disturbances and outages; it also provides clean power to critical loads as servers or other privileged equipment. Depending on the type of operation, protection can be modulated from total (VFI - online double conversion mode) to moderate (VI - line interactive mode) to light (ECO mode). The choice of the operation mode is strictly related to the efficiency of the system and relevant energy consumption.



In general, more is the protection less is the efficiency. While VFI total protection is by far preferred, especially in colocation, VI or ECO lower protection is sometimes accepted in self-owned DC's, to trade off for slightly higher efficiency. In any case the balance between protection and energy savings it to be evaluated properly valued accordingly with the situation, for instance, ECO mode could be useful to reduce unused energy consumption during maintenance periods and use VFI mode when the Servers and other active loads are in full operation.

CONTINUITY

AVAILABILITY

Since the last decade, the concept of design for availability has been backing up pure MTBF-based reliability analysis, which can be used to define the quality of a single system or piece of equipment. Availability assessment is now preferably carried out at site level, by checking the impact of random failures on the infrastructure's ability to keep supplying the IT loads. This is also referred to as "outcome based" availability. Following the above trend, in modern Data Centers a single power feed, even if including UPS units, is no longer considered reliable enough to provide the desired power quality, so multiple layers of redundancy are usually deployed.

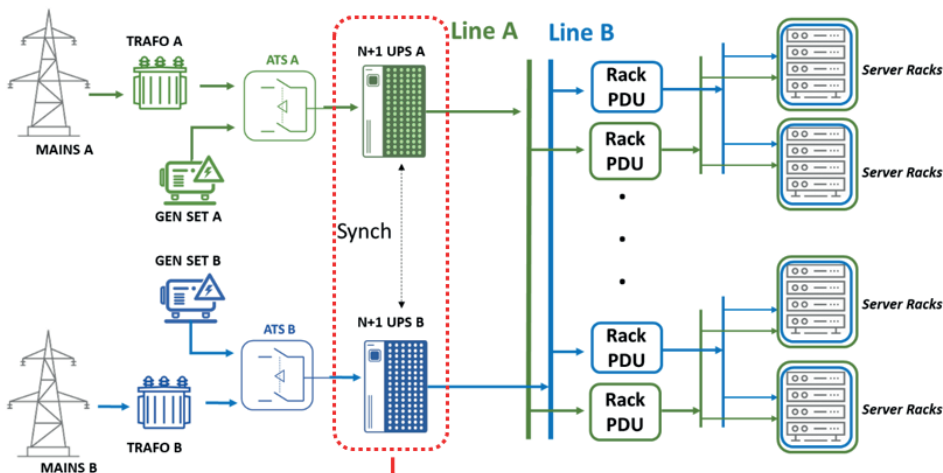

UPSaver 3VO

From 670 kW to 2.67 MW

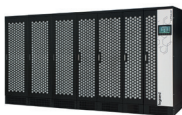

Keor XPE

From 600 kW to 2.1 MW



Keor HPE

From 60 kW to 600 kW



Keor MOD

From 25 kW to 600 kW



Trimod HE

From 3.4 kW to 80 kW



Datacenter with line A and B (level of redundancy 1) and N+1 (level of redundancy 2) both with modular and conventional UPS

Availability (continued)

In this scenario “low MTTR (Mean Time To Repair)”, “N+1 redundancy” and “hot-swap” have been proving pivotal features for any device to be installed upstream critical IT loads and set off the success of modular UPSs in Data Centers.

TYPE OF DATA CENTERS

Hyperscale Data Center

Very large facility own & operated by the company IT supports

- «Super 8» global players
- Specialist brands & international specs by end-user and SI
- Coordination and global specification required
- Go-to-market: direct, IT-distributor acting as global partner

Colocation (Co-Lo) Data Center

Large facility leasing Data Center space for large and small enterprises

- Wholesale: a cage, hall or suite is leased to large businesses
- Retail: from ½ rack to 100 cabinet are leased to SME
- *Colocator* & Consultant decides for any grey area equipment
- Retail: *Colocator* and –possibly- end-user decide
- Wholesale: end-user decides on white room, *Colocator* influences
- Go-to-market: direct to *Colocator* or via distribution

On Premise Data Center

DC own & operated by public & private organisations

- In house IT teams run white space
- Key Account approach for large Data Centre (IT, Government)
- Large DC: specialist brands preferred, End-user & SI decide
- Small DC: turn-key solution preferred, Consultant & SI are key
- Go-to-market: direct or via local distribution

Micro Data Center

Containerized Plug & Play small DC

- Sizes from single rack to container
- For fast deployment in remote locations
- Emerging **edge** market to be assessed
- End-user decides, influenced by SI
- Go-to-market: direct & distribution

CONTINUITY

MEAN TIME TO REPAIR

MTTR is the average time to recover UPS operation after a failure. In modular UPSs MTTR is usually as low as 30 minutes since the typical failure fix consists in replacing the whole power module. To have such a low MTTR, power modules should be plug-in kind, that means no cabling should be needed to connect them to the UPS unit. In conventional UPSs, MTTR depends on the power and the size of the system and it is typically from 1 to 4 hours (as the average repair includes longer disassembling procedures for the inoperative parts). The same MTTR figures can of course be applied to routine maintenance. Although MTTR is not critical whenever redundancy is deployed, low MTTR is still a nice-to-have feature in Data Centers.

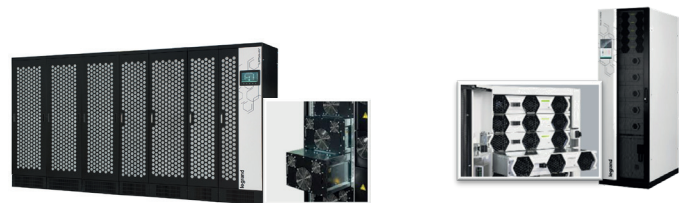

Easy maintenance allows lower MTTR

N+1 REDUNDANCY

"N+1" redundancy implies that there is some spare power available in the UPS system, so that loads can be supplied in VFI double conversion mode after a first failure or during maintenance activities.

It must be noted that if no N+1 redundancy was provided, maintenance could still be performed without load shutdown, by switching the UPS unit under electronic bypass, but even in dual fed redundant electrical systems, this scenario is not the preferred one. To provide N+1 redundancy in modular UPSs, an additional power module is installed on top of the required UPS rating. So, if a 1000 kW N+1 UPS is needed and the power module's size is 333 kW, the installed UPS size will be 1333 kW. On the other hand, N+1 redundancy in conventional UPS is achieved by installing an additional UPS unit on top of the required size. So a 1000 kW N+1 system can be composed by 6 no. 200 kW UPS units in parallel, or 5 no. 250 UPS units, or even 3 no. 500 kW UPS units.

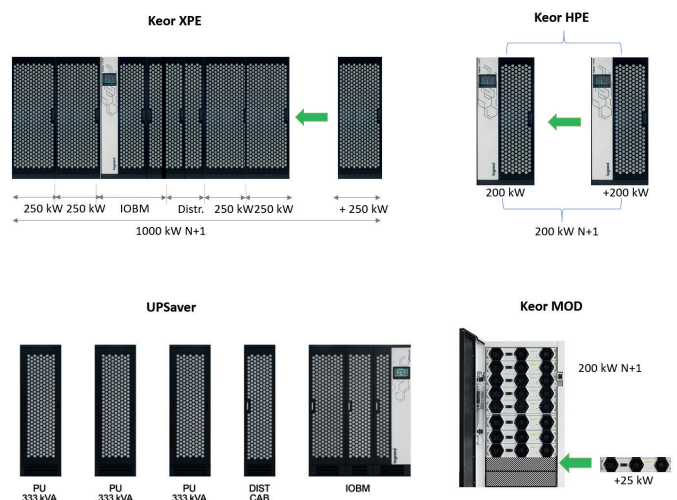

Examples of N+1 redundancy configuration

HOT SWAP

“Hot-swap” allows maintenance and power resizing, or adding or removing some UPS power, without switching the whole UPS unit to bypass. This feature must be combined with N+1 sizing to result in a true hot-swappable system. It must be noted that hot-swappable systems are, by definition, hot-maintainable, whereas the opposite is not always the case. Modular UPS are hot-swappable if a power module (for some UPS also a battery module) can be completely removed or added while the rest of the unit is running and no further software reconfiguration is needed.

In conventional UPS, hot swappability is usually limited to replacing an inoperative UPS unit, as power resizing would require software reconfiguration of the parallel system, therefore they are to be considered Hot-maintainable and not true hot-swappable.

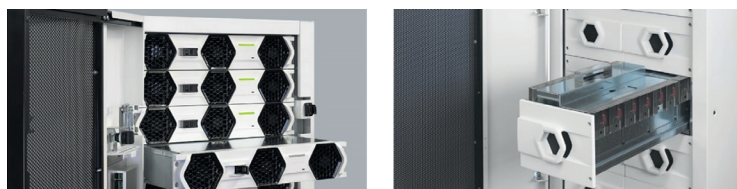

LEGRAND UPS AND BUSINESS CONTINUITY

Model	Modular	Conventional	VFI	ECO	MTR	N+1	Hot Scalability	Hot Maintenance
Keor HPE		✓	✓	✓	1-4 h	✓	✗	✓
Keor MOD	✓		✓	✓	0.5 h	✓	✓	✓
Keor XPE	*scalable		✓	✓	3-6 h	✓	option	✓
UPSaver	✓		✓	✓	0.5 h	✓	✓	✓

UPS ARCHITECTURES

Conventional UPS Stand-Alone and in Parallel

In early years of modern Data Center, UPSs were a unique stand-alone system, generally one cabinet containing all the needed electronics, sized to the nominal power, called Conventional UPS or, sometimes, Monolithic UPS. The availability of the protected load was strictly related to the UPS itself, since a failure of the UPS often corresponded to the breakdown of the load.

One of the solutions for this limit was the introduction of the parallel function: two or more conventional UPS connected in parallel in order to have redundancy (in case one of the UPS fails the other continue to run and protect the load). Keor HPE is the family of conventional UPS by Legrand from 60 to 600 kW, cutting edge technology, high Efficiency and parallelable up to 6 units, for N+X redundancy.



CONTINUITY

Legrand UPS and business continuity (continued)

Modular UPSs

In recent years the need for continuity of power supply and ease of maintenance and management has led to the emergence of UPS with modular architecture. Modular UPS are made up of several transformer-less Online Double Conversion UPS (modules) working in parallel within a single system. The total power of the UPS is the sum of the power of the individual modules. In modular systems it is easy to achieve redundancy or increase the power by simply adding one or more modules, without having to connect several UPS in parallel. Furthermore, in modular UPSs, any faults in the power circuits remain confined within the individual module, which is automatically excluded. The lower the power of the individual modules (granularity), the less power is lost in the event of a fault and the easier it is to replace a faulty module. Typically, the granularity brings high advantage and flexibility with Power Modules of 25 kW or less. Legrand proposes the Keor MOD UPS as the last frontier of Modular Granular System, fully redundant with super compact power modules of 25 kW each, for maximum power of 600 kW.



Salable Systems

At High power levels (from 500 kW up to some MegaWatts), the Redundancy and granularity can be obtained connecting in parallel Modular UPS or using Modular System with big size Power Units in parallel, these systems are also called Scalable. In Scalable systems the Power Units are Conventional UPSs in parallel and connected to a dedicated distribution and control units which manage them as Power Modules, allowing redundancy, hot service and hot scalability. Keor XPE System is the Legrand proposal for Scalable UPS, with Power Units of 250 and 300 kW can reach up to 2.1 MW Power, with possibility to have redundancy, hot serviceability and hot scalability.

Scalable / Modular Construction

A further step in high power and serviceability is to use Scalable UPS with Power Units designed with internal modular construction. This type of system combine together the Flexibility in high power of Scalable UPS with the resilience and serviceability of the Modular granular UPS. Connecting in parallel more of these Scalable Modular System gives the possibility to reach power level over the 20 MW. Legrand offer the UPSaver a top level Scalable Modular UPS System. UPSaver with Power Units of 333 kW (based on 6 sub functional modules), can reach up to 2.67 MW with a single system and up to 21 MW in parallel system, with maximum availability at high power level.



Synchronized UPS Systems

In modern Data Center, with high redundant architecture, it is typical to have dual power lines distribution and to give two independent power sources to active IT load with redundant power supply. In this case each line is protected by one UPS system, often in N+1 redundancy, but, whenever the two lines are separated and independent it could be needed to keep them synchronized. In particular it is important to have a perfect commutation from one line to the other line in case of STS (Static Transfer Switch) systems. (For instance for loads with single power supply stage or in configurations where various UPS lines are distributed through STS to various dual lines part of the Data Center.) Thanks to cutting edge logic controls, Legrand UPS for Data Centers are capable to run in Synchro for dual power lines distributions.

TOTAL COST OF OWNERSHIP

Reducing Total Cost of Ownership (TCO) for all IT critical applications such as Data Center, is one of the most important and relevant objectives for buyers and owners. Today Data Center represents a fundamental structure for a company on which the entire organization depends. For this reason, it is important to ensure its correct functioning and efficiency but ensuring maximum reliability and availability.

DEFINITION:

TCO is the sum of the initial capital expenditures (CAPEX), which includes the cost of equipment and installation expenses, and the ongoing and long-term operational expenditures (OpEx). In addition, predicting and measuring TCO for the physical infrastructure are required for return-on-investment (ROI) analysis and other business decision processes. TCO is a critical metric when designing a new Data Center facility or selecting equipment. Yet, with the explosion of Data Center expansion identifying and weighing the value of TCO variables when specifying, building and operating a Data Center may be more elusive. A simple miscalculation can cost companies millions of dollars every year.

We know that energy is certainly one of those critical TCO variables, as Data Centers are significant consumers of energy. Servers and data equipment account for 55 percent of the energy used by a Data Center, followed by 30 percent for the cooling equipment to keep the facility operational. Electrical power distribution losses, including uninterruptible power supply (UPS) losses, represent a significant 12 percent of energy consumption and the last 3 percent is consumed by lighting.

In each of these areas, energy efficiency gains have a significant impact on TCO and annual operating expenses, especially on high power, long life assets. For example, let's look at just a 1 percent efficiency improvement for a UPS deployment for a 10 megawatt (MW) Data Center. As shown in the chart below, while CapEx is fixed, the OpEx costs of a UPS over 10 years shows an operational savings of \$1.3 million with just an energy efficiency improvement of one percent - from 95.5 to 96.5 percent.

As we can see in the picture above, lifetime costs can quickly exceed initial investments. When budgeting for a new UPS, it's crucial to account for the ongoing Operating Expenses (OPEX) which usually represent between 60-75 % of the TCO. Capital Expenses (CAPEX) instead are easily identifiable and comprise the initial purchase price of the UPS, as well as the costs of installing the UPS, where it will be housed (its physical footprint) and cooling requirements. The initial purchase and installation costs account for between 25-40 % of the TCO.

Thanks to the historical knowledge of Data Center solutions, Legrand pays attention to all life cycle costs generated by the UPS, allowing economic savings over time and a TCO reduction.

The latest generation of Legrand UPS systems have a major impact on Operating expenses, such as:

- Energy efficiency
- Maintenance and servicing
- Battery management
- Component lifetime
- Serviceability

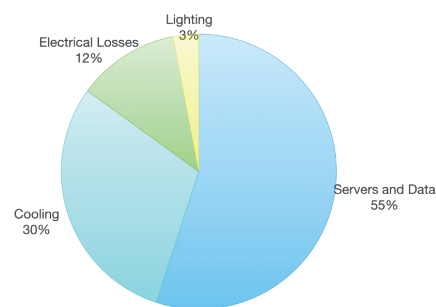

Different component of the energy used

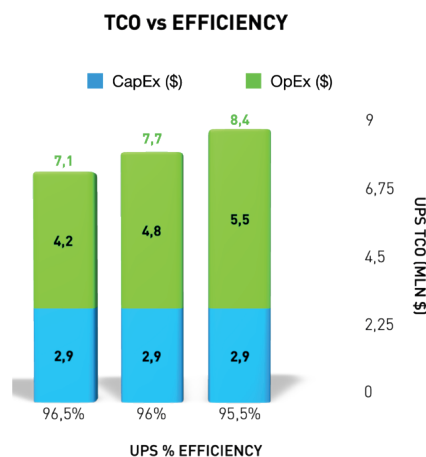

Correlation between TCO and efficiency



TOTAL COST OF OWNERSHIP

ENERGY EFFICIENCY

Increasing energy efficiency is the most important objective for an effective reduction of Operating Expenses for all IT critical applications such as Data Centers, characterized by early years of life with lower and variable load levels over time, usually less than 50 %.

The Legrand UPS solutions respond to the needs for different availability and evolution of the IT infrastructure, thanks to the careful study and use of the latest generation components, which allow the achievement of high efficiency values from lower power levels.

Indeed, starting from a load from 20 % to 50 %, the efficiency curve reaches its maximum range, up to 96.6 % efficiency. Legrand UPS solutions ensure high energy savings starting from low load percentages, typical for this sector, which results into a reduction of carbon dioxide produced, an operating costs saving, allowing a faster return on investments.

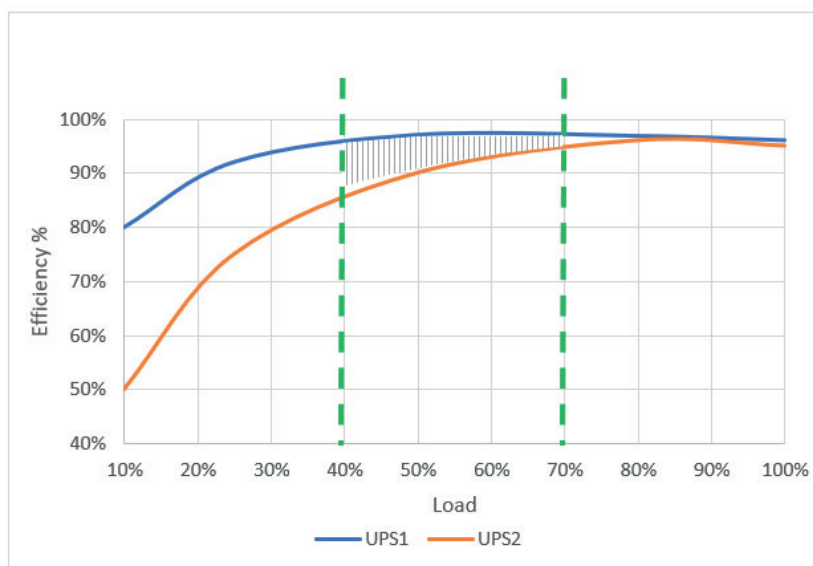

OPTIMIZED EFFICIENCY CURVE

- Maximum values between 25 % and 50 %
- Normally, in IT applications, load is less than 50 %

Legrand UPS' energy savings at low load percentages

In the market it is possible to find many solutions to increase efficiency even over 97 %. It is important in TCO evaluation, to check in which operating mode UPS can reach these high efficiency levels. As indicated before in "Continuity" chapter of this document, it is important to check also the protection level and evaluate, when is acceptable to reduce the protection in order to have higher efficiency or when is preferred to have less efficiency but higher protection. It is probable that avoiding the cost of a down time can justify a little increase of the TCO.

MAINTENANCE AND SERVICING

Maintenance service combines the benefits of preventive maintenance and emergency service for a service entirely tailored to customer needs, considering individual operational constraints, business activity and the unique level of criticality associated with specific applications, minimizing business interruption and the costs of downtime, as well as extending the lifespan of critical power equipment.

Legrand's UPSs are built on the latest developments in power management and proven technologies, in order to make them reliable and resilient and to keep low maintenance and servicing costs.

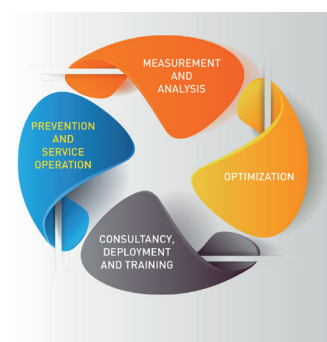

ADVANCED BATTERY MANAGEMENT

Batteries are the most critical component in the reliability of any UPS. Extending battery life can provide significant savings, while neglect can be costly.

To ensure power supply continuity in the event of a power failure, the batteries must be charged and in good condition. Therefore, a part of the energy absorbed by the UPS must be directed to charging the batteries. This is an additional consumption that cannot be eliminated.

Legrand Smart charge battery technology is a unique three-stage charging technique that significantly extends battery service life and optimizes recharge time, compared to traditional trickle charging.

This system is based on the direct measurement of the operating parameters (Voltage and current) of the batteries and their variations in order to monitor the status of the battery in real time. The recharge follows a cycle consisting of several stages, whose duration and intensity depends on the state of the batteries.

This advanced battery charge system has the benefit of having a fast charging time and the batteries are always charged constantly monitored.

At the same time this system does not stress the batteries, because when they reach their full charge, the charging intensity decreases until it reaches zero.

In other words, the smart battery charge system optimizes energy adsorption by limiting it to the amount actually required by the real charging status of the batteries. Moreover, it has the additional effect of extending the batteries' performance and life.

Intelligent Battery Charge System (Smart Battery Charger)

The Smart Charger three-stage intelligent charging system considerably extends batteries' life by even 50 %, thereby halving the number of times they need to be replaced and environmental pollution due to their disposal.

TOTAL COST OF OWNERSHIP

COMPONENT LIFESTYLE

Legrand designs its UPS components to provide a longer lifetime and to enable longer periods between maintenance by increasing their Mean Time Between Failure; for example Keor MOD UPS introduces the new structured energy flow system, that can allow to eliminate all the connection cables inside the power modules. The connections are achieved by the structured increasing the total MTBF.

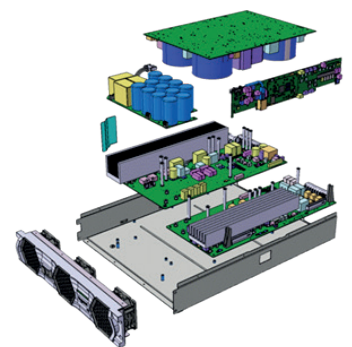

Structured Energy Flow:
no connection cables inside the power module

SERVICEABILITY

Legrand provides a complete range of specific solutions and services to meet customer requirements, using the latest technologies to remotely monitor the systems and perform accurate interventions.

Legrand UPSs are also designed to minimize Mean Time to Repair (MTTR), thanks to modular technology.

Modularity also leads to lower installation and maintenance costs of the UPS. As they are lightweight and compact, the modules are easy to transport and replace. So, it is possible to handle and maintain modular UPS systems with minimum personnel and means of transport and with very little downtime. Moreover, modular machines are "self-configuring" (self-sensing) and do not require programming or hardware or software setting when the modules are installed or replaced. Therefore, no special tools and devices are required to operate with these UPS systems.



Easy service in Legrand UPS

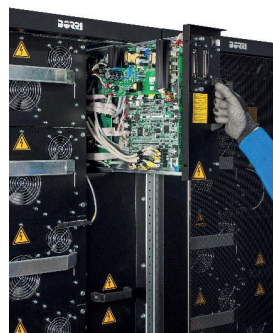

ADAPTABILITY

The intense, fast and constant evolution of the “Digital World” is reflected in frequent modifications’ upgrades and renew of the digital infrastructures. In particular, this happens in Data Centers where the upgrade of active IT devices may often require also the upgrade of the electric system. Furthermore, with new technologies the performances of IT devices are growing but dimensions and consumptions are decreasing; this involves space and costs savings, which can be fully achieved only if also the surrounding infrastructure is able to follow this evolution at the same speed. In addition, during the last few years Data Centers have experienced a huge evolution and diversification in their final scope. In fact, they passed from private company or public office Server Room to Clouds, Colocations, Hybrid, Edge, HyperScale Systems: different power sizes, different services, different management of the IT active load which also means different energy usage and management.

The UPS is fully involved in this evolution since it is the core link between the electric infrastructure and the IT critical load which need full continuity and high-quality energy feeding.

In a nutshell, last generation UPSs must be able to adapt themselves and match both with the load, the surrounding infrastructure and in general with the application; this is the meaning of the word “Adaptability”.

ADAPTABILITY WITH LOAD

There are many different reasons and causes which determine variations in the load and energy absorption.

For instance, regarding IT Active loads:

- In normal activity of a colocation Data Center, servers may be connected or disconnected accordingly with leasing contracts and agreements;
- Data Center managers planned future upgrade or deployment steps to the final regime size of the infrastructure;
- Ordinary or extraordinary maintenance needs to disconnect part of the load keeping in work the other part;
- The IT devices are replaced with new more performing models to reduce the consumptions.
- In an initially underused infrastructure additional IT devices are installed.

There are also cases where the UPS provides energy also to other critical loads different than IT active devices (Servers, Storages, etc). For instance, the UPS may be used to have continuity also for light, surveillance, safety and cooling systems. These loads may have several and variable types of energy absorptions and running conditions.

The UPS must be able to guarantee all the functionalities with the best performances in all the expected situation of load variation and promptly match any evolution of the installed load.

This is possible thanks to high quality electronics and firmware design and equipment combined with native architecture, which allows easy and reliable power configurations and future upgrade.

Modularity, Scalability and Parallel allows to satisfy the energy needs making the UPS “Adaptable” to the load.

ADAPTABILITY

HIGH AND CONSTANT EFFICIENCY

At various load level (available in Trimod HE, Keor MOD, Keor HPE, Keor XPE).

Example 1: In case of ordinary maintenance, the load decreases for one week from 75 % to 50 %.

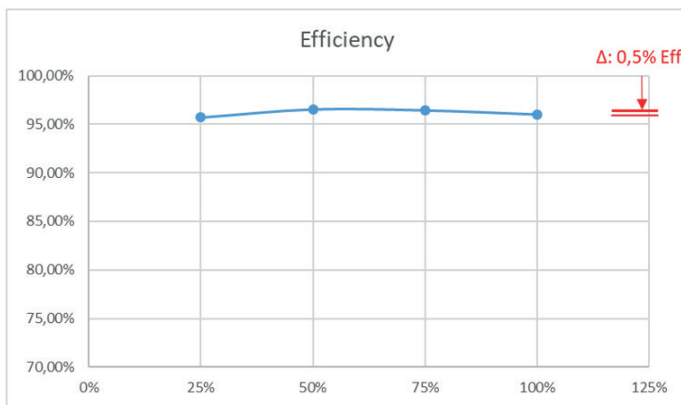

Load decrease in case of maintenance

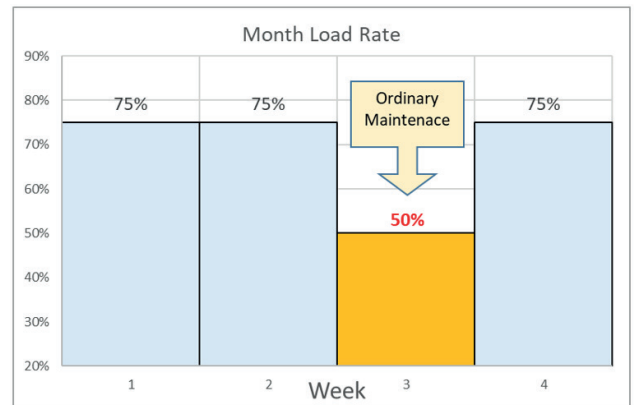

Example 2: UPS dedicate to Cooling system and other building critical systems (not active IT Device).

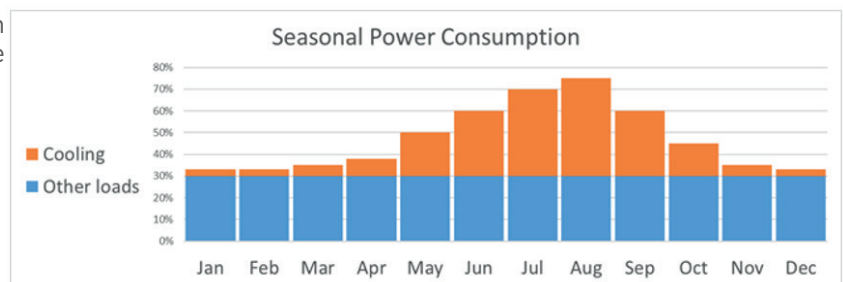

Seasonal power consumption

The “not IT Active load” in the building can be considered constant but the consumption of the cooling system may change a lot along the year, accordingly with geographical climate. In the example the variation is up to 35 % of UPS nominal power.

Thanks to constant high efficiency there is minimum efficiency variation even in case of important load variation: in the two examples above the difference of efficiency is just 0.5 % against a load variation of 30-35 %.

SCALABILITY

Example1: Keor XPE, Pay as you grow. Project deployed and realized in several steps of load connection, infrastructure designed for 2.1 MW but starting from 1.2 MW load, increasing 300 kW in 3 steps up to nominal power at the regime.

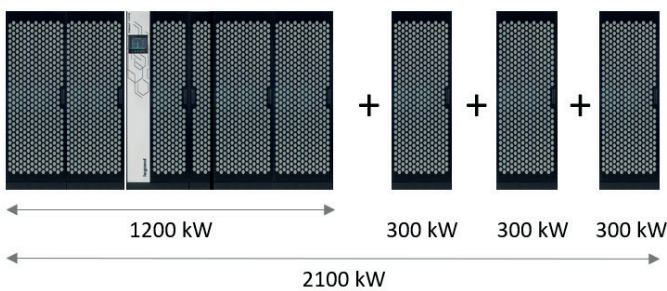

Example of Keor XPE scalability

Example2: Keor MOD, Pay as you need. Additional servers are installed and activated in server farm Racks, UPS can be easily upgraded without change the infrastructure.

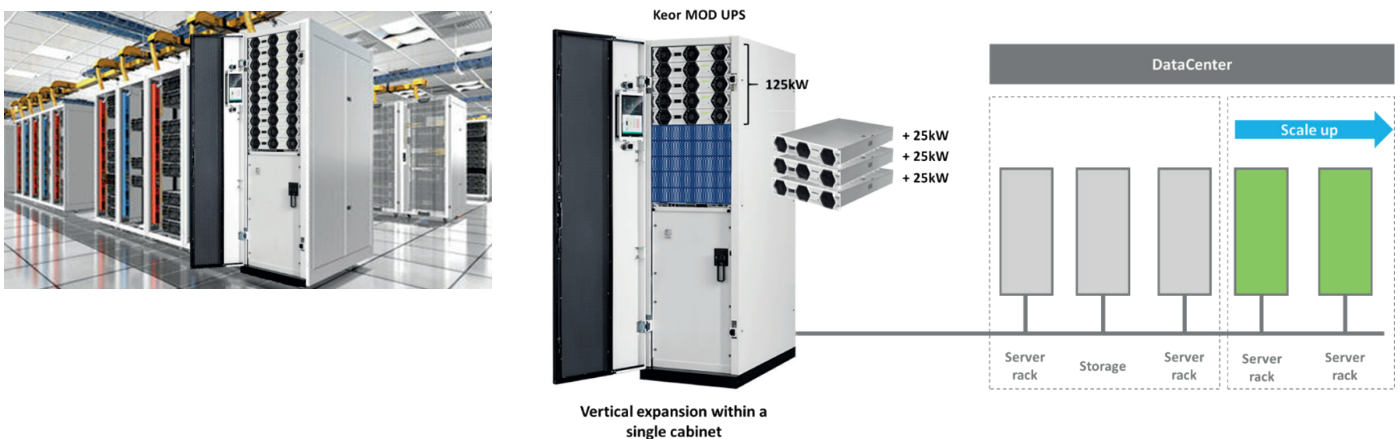

New Servers installed in free Rack Slots – New Power Modules installed in the UPS to feed the new device (Keor MOD)s

ADAPTABILITY

ADAPTABILITY WITH ELECTRICAL INFRASTRUCTURES

Electric infrastructures in Data Centers can be various and very specific according to the power size, geographical positions, local laws, technical/design choices, building typology and other several reasons.

Electric infrastructure may also change along the time, in case of renewal, reorganization or enlargement of the Data Center. In other cases, the room and the electric system already exist, they were originally used for other applications and currently are supposed to house a server farm or other IT infrastructures.

A UPS which is designed to be compatible (natively or easily configurable) with various electric infrastructures is, for sure, a great advantage with consequent time and cost saving. In particular, it is very useful to have full compatibility with the various grounding systems, easy and comfortable electric connections, suitability different electric connections (cable/busbars), in/out signal port to coordinate the UPS operations with surrounding distribution and protection devices.

Another important feature of the UPS is the extremely low electric impact on the electric network. Minimum harmonics pollution and zero reactive power absorption are, nowadays, a basic requirement and are as essential as a clean and stable output voltage; but UPSs for Data Centers must be also full compatible with isolation transformers, GenSet, ATS, STS and other devices which are typically used in Data Centers electric systems.

Legrand UPS are designed to be compatible with wide scenarios of electric systems.

They are all compatible with the different grounding system, can work with isolation trafo both in input and output. They have dedicated controls for input absorption which makes them suitable to work with GenSet, ATS and other upstream systems. Input, bypass and output performances make the Legrand UPS fully compatible with all the electric distribution items of Legrand portfolio for a complete integrated Electric infrastructure both for grey and white room of the Data Center.

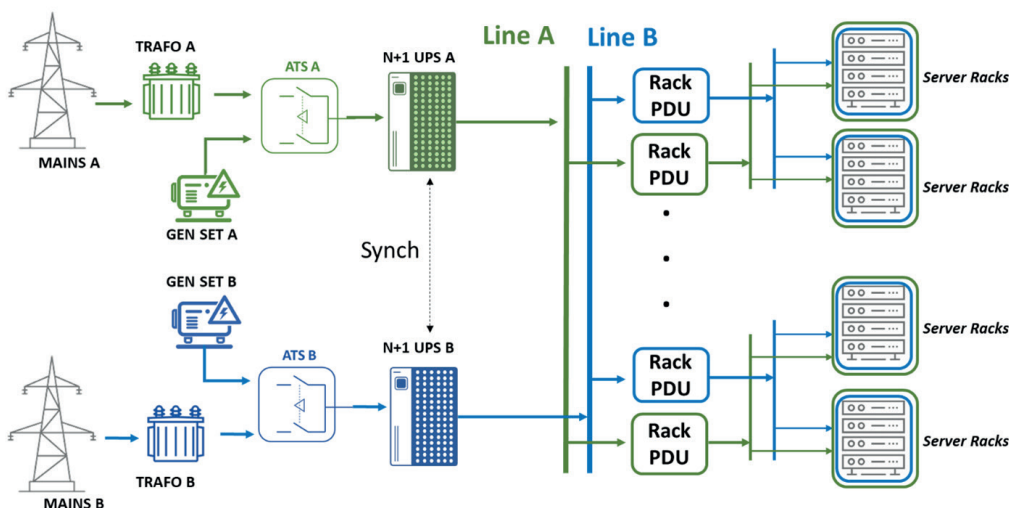
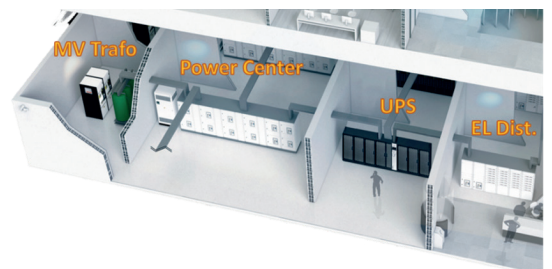

Compatibility with various configurations of the Electrical System

Adaptability with electrical infrastructures (continued)

For small-medium power Legrand UPS can be easily connected with cables at the bottom front of the cabinet. This is particularly useful and comfortable in case of cabling passing under technical floor. Nonetheless the UPS can easily be connected also with cable coming from the top cable trays.

For large power Systems UPS can be connected both to cables and busbar power lines.

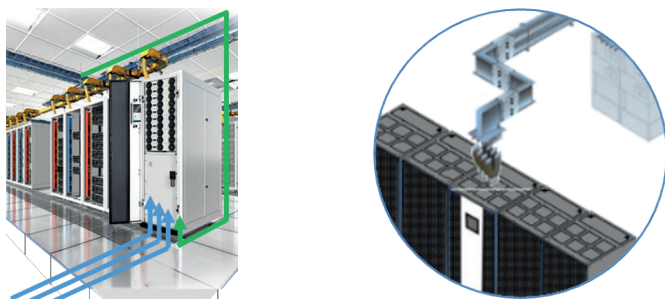

Connection with cables and busbars is possible

ADAPTABILITY TO THE ROOM AND BUILDING

Data Centers managers and designers pay great attention to the room space and footprint. In fact, both the occupied and available space have a deep impact on costs and potential value of the infrastructure; in order to reduce the first factor and increase the second one, it is fundamental to dedicate as much space as possible to active devices (rack for servers and storage) and reduce to a minimum the space used by the rest of the technical infrastructure, UPS included.

For this reason, the UPS for Data Centers must have the highest level of power density and mechanical compactness. Small footprint with compact cabinets, combined with wheels and adjustable feet, makes the UPS adaptable to the building and technical room also in case of installation, movement and building renovation. Modular systems, with small power modules, are furtherly comfortable and preferable due to the possibility for very few technicians to move empty cabinets and modules and install them only after the final positioning easily and quickly. Even In case of high-power UPSs (>500 kW), modular architecture, helps to simplify the movement, positioning and installation inside the building, as these big UPS systems are made of a combination of several units in smaller cabinets. Furthermore it can be very useful and interesting for a big power UPS to have the possibility to place the cabinets of its components not only in line (side by side), but also along the walls (in L shape or U shape) or at the center of the room (back to back). Similarly, the possibility to skip structural obstacles (e.g. pillars) by placing the single cabinets of components it is useful as well.

The Adaptability of the UPS to the technical room (accordingly with the case it could be Grey Room or Withe Room), is also related to the environmental specs, proper ventilation system, mechanical compatibility with active load racks, cold corridors and power distribution systems.

ADAPTABILITY

Adaptability to the room and building (continued)

For best usage of the available space in Data Centers, Legrand UPS are designed to have ones of the highest level of power density in the market with consequent compact footprint.

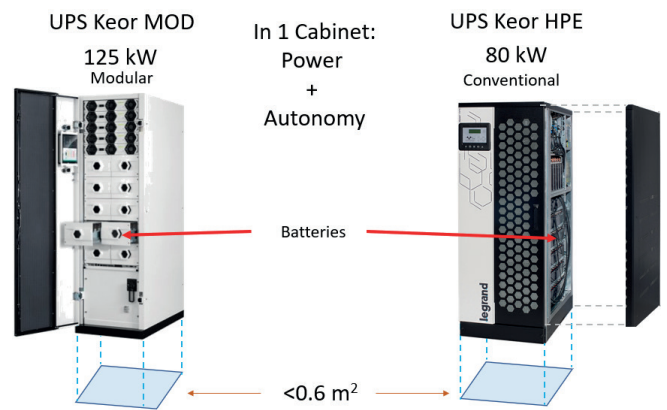

High power density and compact footprint

Ventilation system in Legrand UPS Keor MOD is designed to match the air flow strategy in the Data Center white room, compatible with hot and cold aisles and with enclosed cold corridors.

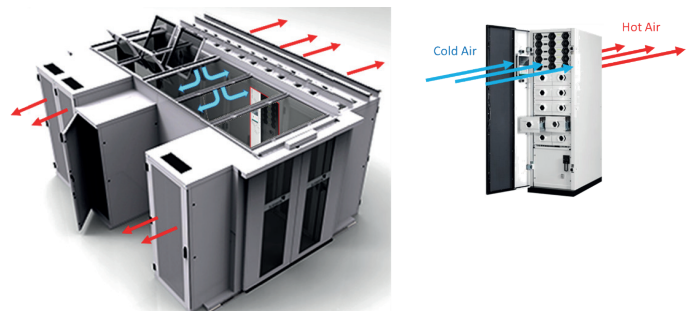

Ventilation compatible with cold corridor systems

Ventilation in Legrand UPS Keor HPE is designed to flow from top and front, without the need of free space on the rear side of the cabinet for easy installation against the wall.

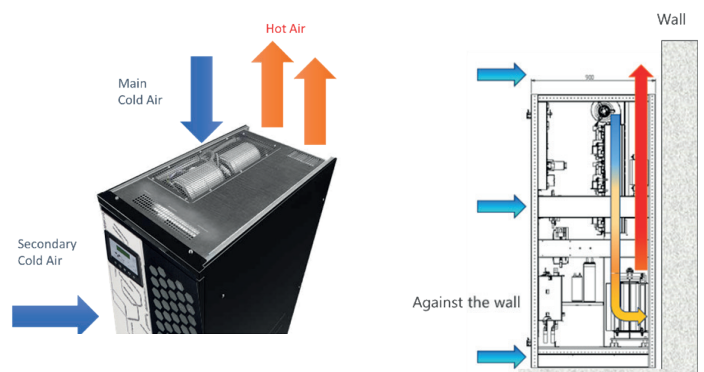

Top and front ventilation allow installation against the wall with floor space savings

Adaptability to the room and building (continued)

For Large systems like Keor XPE and UPSaver composed by several cabinets, Legrand offers the possibility of free positioning of the individual cabinets in order to optimize the occupation of room space, for instance following the wall or placing the cabinets in the center of the room and may other layout. In addition, the free positioning of cabinets, allows to skip structural obstacle like pillars, doors, etc.

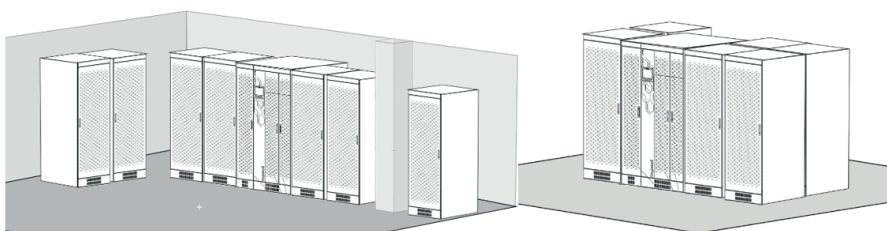

Customizable layout for footprint optimization

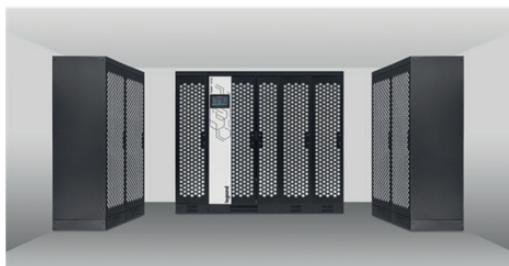

Example of Keor XPE/UPSaver layout

ADAPTABILITY TO THE APPLICATION AND USER

The last “side” of Adaptability is toward the application and the user. In Data Center the core of the application is the treatment and the storage of the data inside the active devices. The value of these activities is so high that they must be constantly kept active, protected and controlled.

This means that all the infrastructure which supports and holds up the active load must be monitored, controlled and integrated in automatic diagnostic and process management. For this reason, the UPS for Data Center should have a full set of communication interfaces with the most popular protocols and compatible with all operating systems, which allow the full integration in Data Center data networks.

Finally the UPS for Data Center should be adaptable also to the user, with intuitive, simple and immediate display and human interface: these elements should clearly show the status of the system and with few “taps” allow complete monitoring, control and, with proper protections, set up and diagnostics actions.

ADAPTABILITY

Adaptability to the application and user (continued)

Legrand pays particular attention for the ergonomics of the UPS with the User and the Application and reach high level of usability and integration for the best experience in UPS management. (USB, Dry Contacts, RS232, RS485, ModBUS, Ethernet, Parallel, IN/Out Logic signals, etc.)



Full Communication Ports and Interfaces

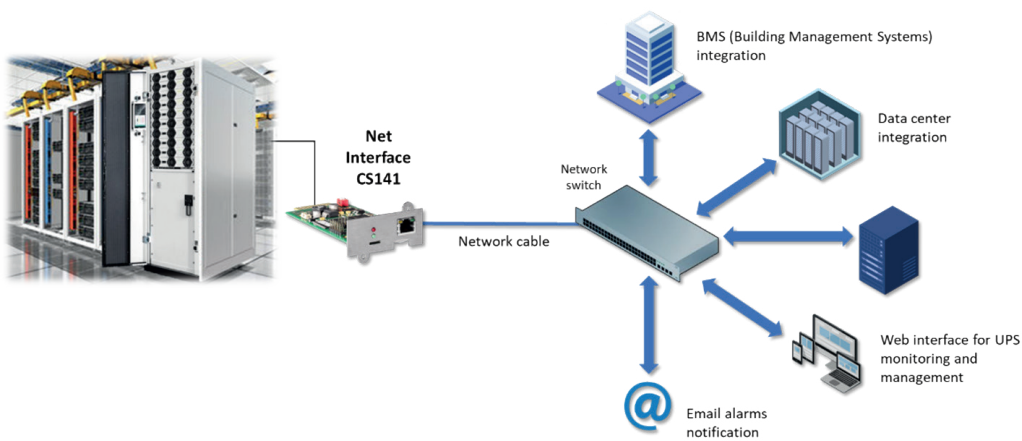

Full integration with Data Center Network for remote monitoring, control and management

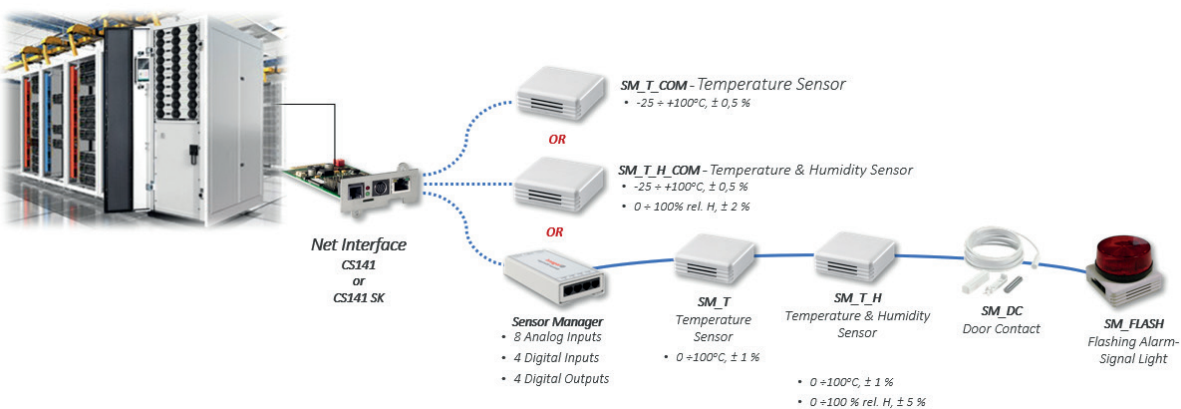

Many possibilities of environmental and room monitoring

CONCLUSION

In conclusion, today Data Centers need smart solutions which combine agility, effectiveness, and sustainability for each single component. For sure, in this, it is involved also the UPS, which has the main target to provide continuous and high quality energy supply, but can give added value if it can contribute to make the system easier to manage, flexible to evolve, reliable and affordable.

The added value can be summarized in the three main points:

- Business continuity
- Limited TCO
- Adaptability





The nowadays trends of technology and applications show all the evidences to suppose that the future evolution in Data Center will focus on the improvements of these three main features paying more and more attention also to Eco sustainability and environmental impact of the overall system.

Modular-Scalable architecture, attention to design and material, advanced logic controls, innovation and research will bring big achievements for future evolution.

Legrand UPS with its complete UPS portfolio and in accordance with its policy of continuous improvement, is fully engaged to study and develop cutting edge solution for Data Center and, in general, for critical applications.



FOLLOW US ALSO ON

- @ legrand.com
-  youtube.com/user/legrand
-  facebook.com/Legrand
-  twitter.com/Legrand
-  pinterest.com/legrandgroup
-  instagram.com/legrandnews



Head office
and International Department
87045 Limoges Cedex - France
Tel: + 33 (0) 5 55 06 87 87
Fax: + 33 (0) 5 55 06 74 55