

WHITE PAPER

# RELIABILITY & AVAILABILITY IN LEGRAND UPS



## LEGAL INFORMATION

Particular attention must be paid on presentation pictures that do not include personal protective equipment (PPE). PPE are legal and regulatory obligations.

In accordance with its continuous improvement policy, Legrand reserves the right to change the specifications and illustrations without notice. All illustrations, descriptions and technical information included in this document are provided as indications and cannot be held against Legrand.

# TABLE OF CONTENTS

DEFINITIONS & PARAMETERS .....	4
RELIABILITY BLOCK DIAGRAM (RBD) METHOD.....	5
FAILURE RATE .....	6
RELIABILITY UPS WITH STATIC BYPASS SWITCH .....	7
RELIABILITY OF CONVENTIONAL UPS IN PARALLEL (REDUNDANCY AND POWER) .....	8
RELIABILITY IN MODULAR UPS WITH N+X REDUNDANCY.....	9
CONCLUSION.....	10
RELIABILITY VALUES FOR LEGRAND 3-PHASE UPS FAMILIES AND MODELS.....	11
Conventional UPS Transformer Free .....	11
Conventional UPS Transformer Based .....	13
Modular UPS .....	14

# DEFINITIONS AND PARAMETERS

## ■ Failure

The termination of the ability of an item to perform a required function. For an UPS the failure is defined as the termination to supply the load.

## ■ Reliability

The ability of an item to perform a required function under given conditions for a given time interval.

For an UPS the reliability is the capacity to supply the load without any interruption and without any voltage and frequency variation.

## ■ Failure Rate ( $\lambda$ )

Is the number of failures per million of hours.

The failure rate is time dependent. It is related to the overall quality of the product (material, design, production) but also to the useability and maintainability.

## ■ Mean time between failure (MTBF)

The MTBF is the expectation of the time between failures. For an UPS is the average time between two failures.

$$MTBF = \frac{1}{\lambda}$$

## ■ Mean time to repair (MTTR)

The MTTR is the average time needed to complete a system repair, strongly related to the system architecture and design for easy and fast diagnosis and service.

## ■ Repair Rate

$$\mu = \frac{1}{(MTTR)}$$

## ■ Availability (A)

The ability of an item to be in a state to perform a required function under given conditions at a given instant of time or over a given time interval, assuming that the required external resources are provided.

$$A = \frac{MTBF}{(MTBF + MTTR)}$$

Obviously A is always less than one (it is one in ideal case of MTTR = 0). Typically it is expressed as percentage of running time during the system life and it is commonly indicated with number of « nines », for instance :

A=99.9952%.... is « four nines »

A=99.99973%.... is « five nines »

A=99.9999845%.... is « six nines »

For critical application when the « Never Stop » is the main target, Availability is very useful (more than just failure rate and MTTR considered separated) to figure and compare the reliability of systems.

In fact a system with a low failure rate could have less availability respect to a system with higher failure rate, because it needs more time to be repaired. For example considering 3 systems:

MTBF	MTTR	Availability	« Nines »	Average downtime in a year
1,000,000 h	15 h	99.9985 %	4 Nines	8 minutes
800,000 h	2 h	99.9998 %	5 Nines	1.3 minutes
400,000 h	0.5 h	99.9999 %	6 Nines	39 seconds

# RELIABILITY BLOCK DIAGRAM (RBD) METHOD

With the RBD Method the System is divided in smaller blocks or sub-systems with well defined  $m$  and  $r$  (MTBF and MTTR). The reliability of the entire system is the combination of the reliability of the single blocks. In particular, from the reliability point of view, the blocks can be connected in series or in parallel:

- In a system of Blocks in Series, if only one block fails all the system fails.
- In a system of Blocks in Parallel, the system fails when all the blocks fail.
- In the simple case of only two blocks with:

$$\begin{aligned} \text{MTBF}_1 &= m_1 \\ \text{MTTR}_1 &= r_1 \\ \text{MTBF}_2 &= m_2 \\ \text{MTTR}_2 &= r_2 \end{aligned}$$

The combination formulas to calculate the MTBF ( $m_s$ ) and MTTR ( $r_s$ ) of the systems are the following:

## Reliability Series Connection:

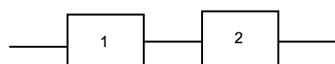

$$\begin{aligned} m_s &= \frac{m_1 \times m_2}{m_1 + m_2} \\ r_s &= \frac{m_1 \times r_2 + m_2 \times r_1}{m_1 + m_2} \end{aligned}$$

## Reliability Parallel Connection:

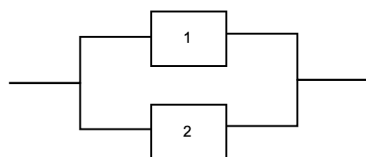

$$\begin{aligned} m_s &= \frac{m_1 \times m_2 + (m_1 \times r_2 + m_2 \times r_1)}{r_1 + r_2} \\ r_s &= \frac{r_1 \times r_2}{r_1 + r_2} \end{aligned}$$

# FAILURE RATE

The failure rate in the life cycle of a product is not constant and typically the trend is the one in below figures called « Barh Curve »:

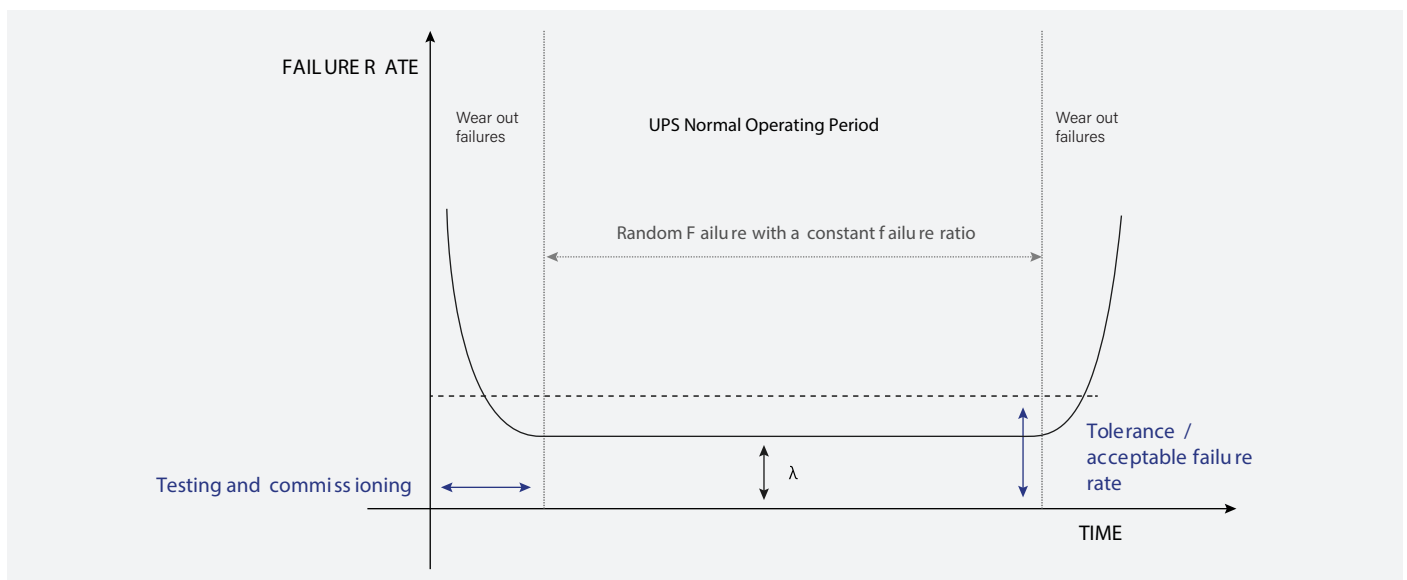

Figure 1: Failure rate ( $\lambda$ ) as function of the time

The curve is divided into three periods: the wear-in failure period, the normal operating period and the wear-out failures period. During the wear-in failure period the failure rate is relatively high (it is called also infant mortality period). This period usually happens during the factory test and burn-in. The wear-out failure period happens when the UPS is near to the end of its useful life.

The UPS normal operating life is the useful life of the system. During this period the failure rate is constant. There is no direct correlation between the service life of a product and its failure rate.

The MTBF value is based on the rate of failure of the UPS while still in its normal operating life and it is assumed that it will continue to fail at this rate indefinitely. MTTR is the expected time to recover the UPS from a failure.

# RELIABILITY UPS WITH STATIC BYPASS SWITCH

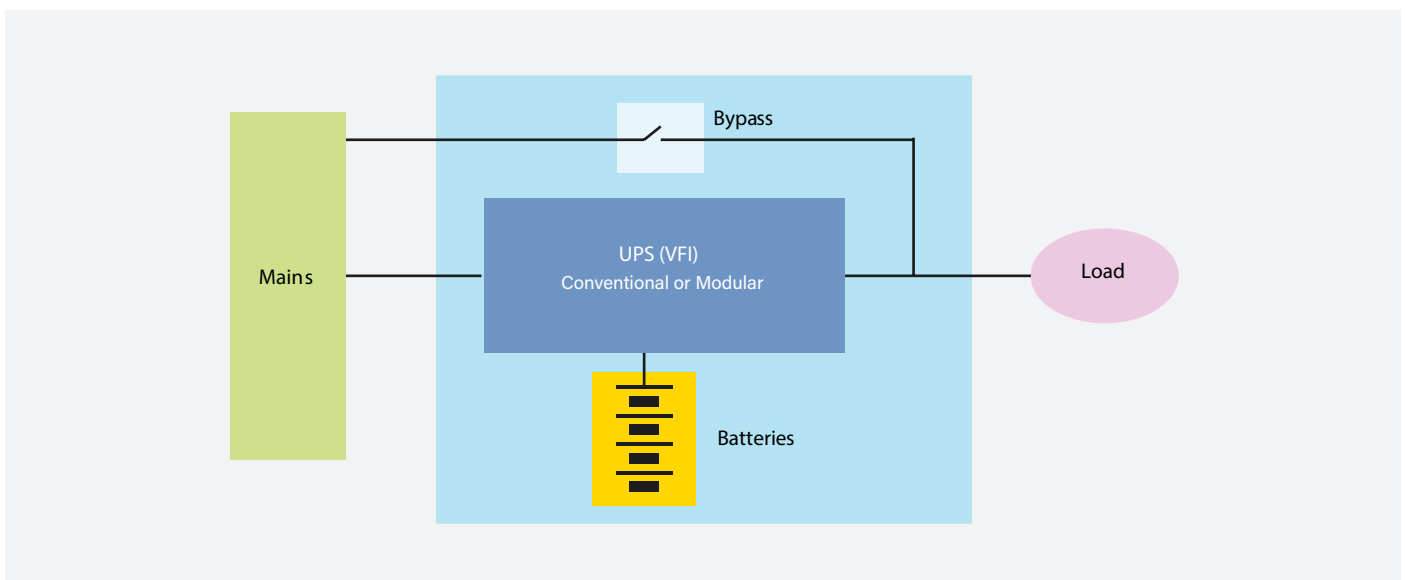

Figure 2: Schematic Block Diagram of UPS system

Using the configuration given in the figure 2 the reliability of the System depends on the MTBF and MTTR of the UPS, but also on the MTBF and MTTR of the “utility mains”. In fact in case of UPS failure but Mains available the load continues to run with energy flowing trough the bypass.

A possible assumption for Utility Mains is:

- Mains Utility MTBF = 100 h
- Mains Utility MTTR= 12 h

# RELIABILITY OF CONVENTIONAL UPS IN PARALLEL (REDUNDANCY AND POWER)

The reliability of a single UPS can be increased significantly by introducing a redundant parallel configuration. The (n+1) parallel active redundant system stands for the number of UPS modules that are required to handle an adequate supply of power for essential connected systems, plus one more.

The following diagrams show the Parallel Redundant Configuration (n+1) with internal and external manual maintenance bypass.

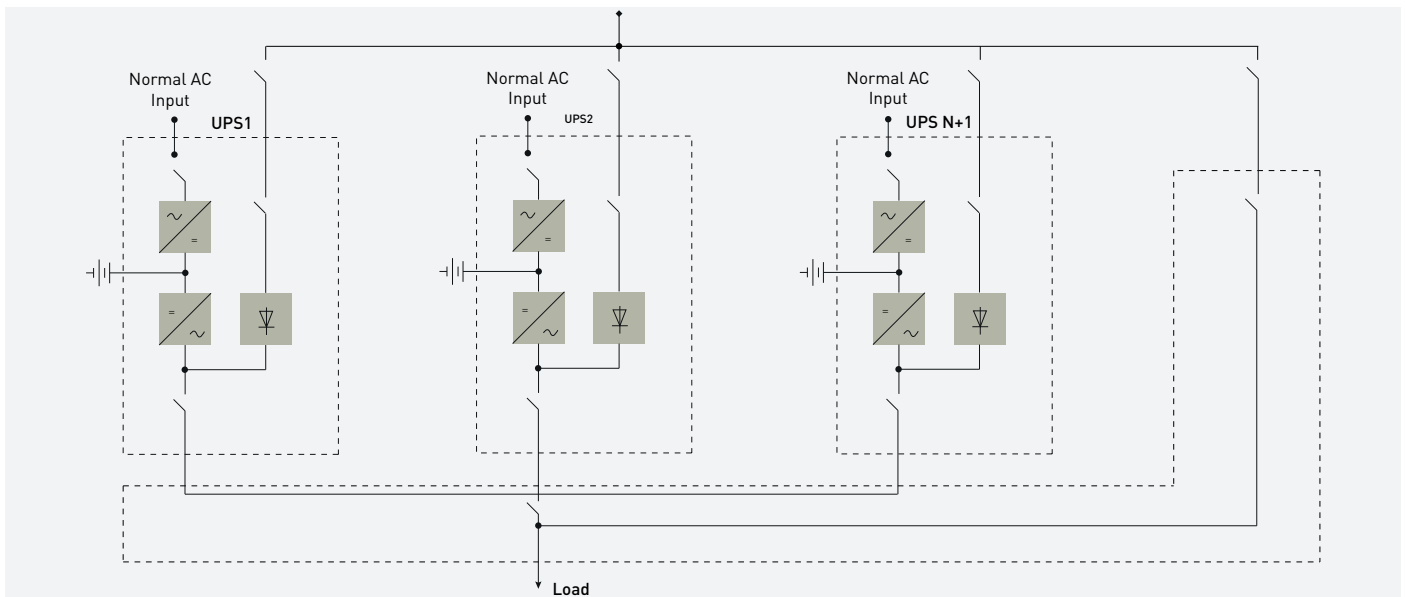

Figure 3: Redundant Parallel Configuration with external maintenance bypass

The reliability of the redundant system depends principally on any commonality in the system. On the other hand Conventional UPS connected in parallel for power, and not for redundancy, result with lower MTBF compared to a single UPS. This because any failure in each of the two UPS will cause the shutdown of the load.



# RELIABILITY IN MODULAR UPS WITH N+X REDUNDANCY

Independently of the failure rate, Modular UPS system have the big advantage versus Conventional UPS to have very short MTTR. In fact, in most of the cases, the repair is just the replacement of a faulty module, and smaller is the module (high granularity) shorter is the MTTR.

In reliability calculation, in case of redundancy N+X, modular UPS can be considered similar to conventional UPS in parallel, but with the big differences that they have less common blocks, in particular in full modular architecture where all components are distributed (included logic, static bypass, batteries, etc.). This compensate the higher number of blocks which can fails with the high redundancy level and independency of them.

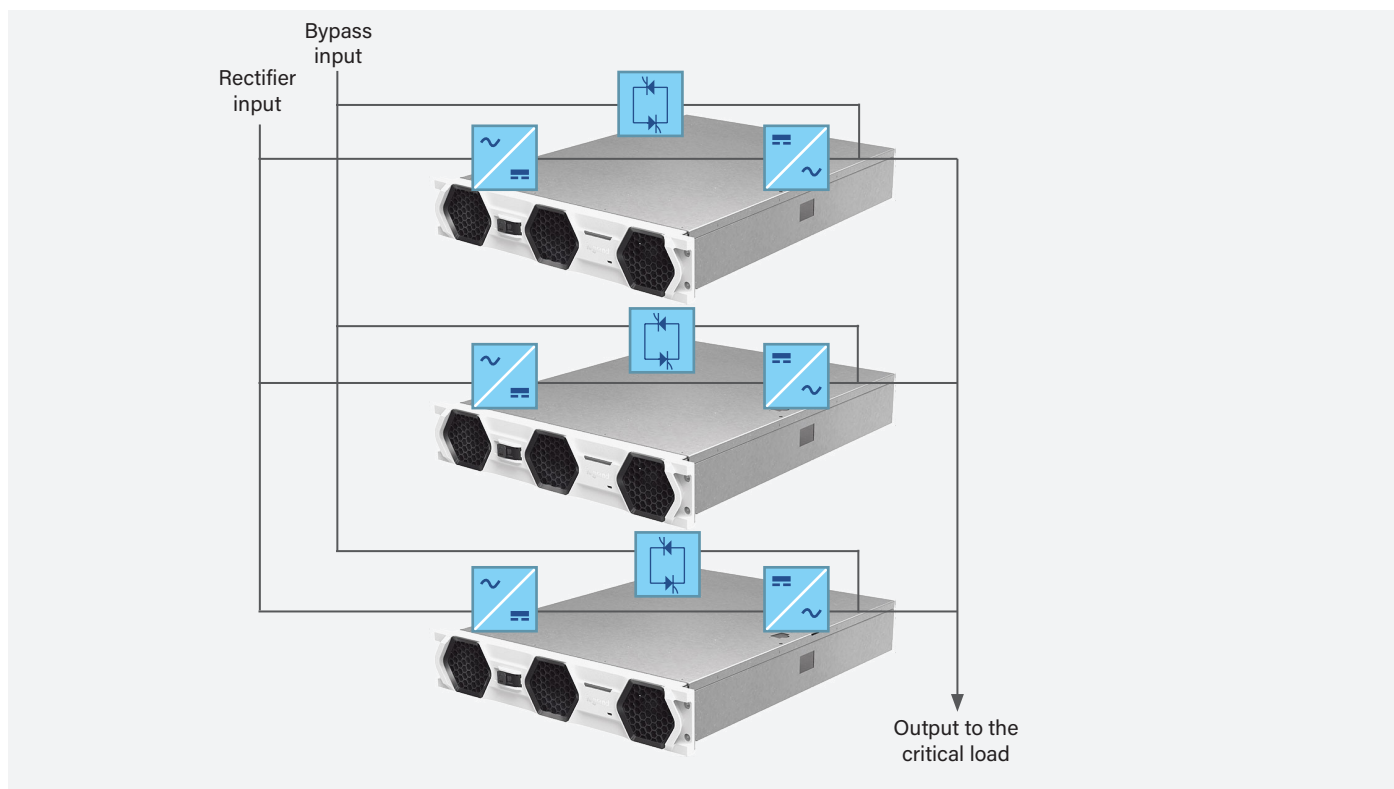

Figure 4: Modular UPS with N+X Redundancy

# CONCLUSION

The MTBF of a stand-alone UPS with a static bypass line depends to some extent on the MTBF mains and the MTTRUPS.

Paralleling UPS units for redundancy increases system reliability significantly because the MTTR UPS is very small compared to the MTBF UPS of each individual module.

Paralleling UPS just for power decrease the system reliability introducing additional single point of failures compared to the case of only one unit.

Modular UPS are more complex respect Conventional UPS because composed by more blocks. In "Not Redundant" configurations increasing number of modules could have negative effects on the MTBF but this is balancing by the big advantage of very short MTTR, which brings high level of Availability.

Modular UPS in "N+1 Redundant" configurations can reach even higher Availability thanks to the very high level of decentralization and redundancy with many independent modules in parallel.

# RELIABILITY VALUES FOR LEGRAND 3-PHASE UPS FAMILIES AND MODELS

## CONVENTIONAL UPS TRANSFORMER FREE

	Keor T EVO 10-60 kVA				
	Result	Availability	MTTR (h)	MTBF (h)	Nines
	Single UPS	99.9995 %	2.4	437000	5 Nines
	N+1	99.9996 %	2.0	487000	5 Nines
2N	99.9987 %	2.8	219000	4 Nines	

	Keor HPE 60-80 kVA				
	Result	Availability	MTTR (h)	MTBF (h)	Nines
	Single UPS	99.9997 %	1.5	490000	5 Nines
	N+1	99.9998 %	1.0	490552	5 Nines
2N	99.9993 %	1.6	245000	5 Nines	

# RELIABILITY VALUES FOR LEGRAND 3PHASE UPS FAMILIES AND MODELS

## CONVENTIONAL UPS TRANSFORMER FREE (CONTINUED)

	Keor HPE 100-160 kVA				
	Result	Availability	MTTR (h)	MTBF (h)	Nines
	Single UPS	99.9994 %	2.9	463000	5 Nines
	N+1	99.9994 %	3.0	487000	5 Nines
2N	99.9986 %	3.5	250000	4 Nines	

	Keor HPE 200-300 kVA				
	Result	Availability	MTTR (h)	MTBF (h)	Nines
	Single UPS	99.9993 %	3.3	460000	5 Nines
	N+1	99.9994 %	3.0	487000	5 Nines
2N	99.9982 %	4.1	230000	4 Nines	

	Keor HPE 400-500 kVA				
	Result	Availability	MTTR (h)	MTBF (h)	Nines
	Single UPS	99.9993 %	3.3	480000	5 Nines
	N+1	99.9994 %	3.0	487000	5 Nines
2N	99.9983 %	4.1	240000	4 Nines	

## CONVENTIONAL UPS TRANSFORMER BASED

	Keor HP 100-160 kVA				
	Result	Availability	MTTR (h)	MTBF (h)	Nines
	Single UPS	99.9990 %	4.0	437000	5 Nines
	N+1	99.9993 %	3.0	487000	5 Nines
2N	99.9971 %	5.7	219000	4 Nines	

	Keor HP 200-300 kVA				
	Result	Availability	MTTR (h)	MTBF (h)	Nines
	Single UPS	99.9990 %	3.9	490000	5 Nines
	N+1	99.9993 %	3.0	490552	5 Nines
2N	99.9971 %	5.6	245000	5 Nines	

	Keor HP 400-500 kVA				
	Result	Availability	MTTR (h)	MTBF (h)	Nines
	Single UPS	99.9990 %	4.4	463000	5 Nines
	N+1	99.9992 %	4.0	487000	5 Nines
2N	99.9971 %	6.0	250000	4 Nines	

	Keor HP 600-800 kVA				
	Result	Availability	MTTR (h)	MTBF (h)	Nines
	Single UPS	99.9991 %	4.4	437000	5 Nines
	N+1	99.9993 %	4.0	487000	5 Nines
2N	99.9974 %	6.2	219000	4 Nines	



# RELIABILITY VALUES FOR LEGRAND 3PHASE UPS FAMILIES AND MODELS

## MODULAR UPS



	Keor MOD	Non-Redundant Configuration			
	Power kW	Availability	MTTR (h)	MTBF (h)	Nines
	25	99.9997 %	1.7	665000	5 Nines
	50	99.9997 %	1.5	549000	5 Nines
	75	99.9997 %	1.3	467000	5 Nines
	100	99.9997 %	1.2	407000	5 Nines
	125	99.9997 %	1.1	360000	5 Nines
	150	99.9997 %	1.1	323000	5 Nines
	175	99.9997 %	1.0	293000	5 Nines
	200	99.9994 %	1.3	234000	5 Nines
	225	99.9994 %	1.2	204000	5 Nines
	250	99.9994 %	1.1	180000	5 Nines

	Keor MOD	N+1 Redundant Configuration			
	Power kW	Availability	MTTR (h)	MTBF (h)	Nines
	25	99.9999 %	0.40	670000	6 Nines
	50	99.9999 %	0.41	580000	6 Nines
	75	99.9999 %	0.43	500000	6 Nines
	100	99.9999 %	0.44	450000	6 Nines
	125	99.9999 %	0.45	390000	5 Nines
	150	99.9999 %	0.47	330000	5 Nines
	175	99.9998 %	0.48	300000	5 Nines
	200	99.9998 %	0.50	275000	5 Nines
	225	99.9998 %	0.51	260000	5 Nines

## MODULAR UPS (CONTINUED)

Trimod HE	Non-Redundant Configuration (for both Single-phase and 3-phase)				
	Power kW	Availability	MTTR (h)	MTBF (h)	Nines
	10	99.9996 %	1.6	430000	5 Nines
	15	99.9996 %	1.6	430000	5 Nines
	20	99.9996 %	1.6	430000	5 Nines
	30	99.9996 %	1.3	370000	5 Nines
	40	99.9996 %	1.3	370000	5 Nines
	60	99.9996 %	1.2	310000	5 Nines
	80	99.9997 %	1.1	310000	5 Nines

Trimod HE	3-phase Out N+1 Redundant Configuration				
	Power kW	Availability	MTTR (h)	MTBF (h)	Nines
	10	99.99989 %	0.50	465000	5 Nines
	15	99.99989 %	0.50	465000	5 Nines
	20	99.99989 %	0.50	465000	5 Nines
	30	99.99988 %	0.50	420000	5 Nines
	40	99.99988 %	0.50	420000	5 Nines
	60	99.99987 %	0.50	390000	5 Nines

Trimod HE	Single-phase Out N+1 Redundant Configuration				
	Power kW	Availability	MTTR (h)	MTBF (h)	Nines
	5	99.99990 %	0.50	485000	6 Nines
	6,7	99.99990 %	0.50	485000	6 Nines
	10	99.99988 %	0.50	420000	5 Nines
	13,3	99.99988 %	0.50	420000	5 Nines
	15	99.99987 %	0.50	371400	5 Nines
	20	99.99985 %	0.50	332800	5 Nines
	25	99.99983 %	0.50	301500	5 Nines

# RELIABILITY VALUES FOR LEGRAND 3PHASE UPS FAMILIES AND MODELS

## MODULAR UPS (CONTINUED)

	Keor XPE	Non-Redundant Configuration			
	Power kW	Availability	MTTR (h)	MTBF (h)	Nines
	600	0.999995 %	4	792000	5 Nines
	750	0.999993 %	4	590000	5 Nines
	900	0.999993 %	4	590000	5 Nines
	1000	0.999992 %	4	470000	5 Nines
	1200	0.999992 %	4	470000	5 Nines
	1500	0.999990 %	4	390000	5 Nines
	1800	0.999990 %	4	390000	5 Nines
	2100	0.999987 %	4	300000	5 Nines

	Keor XPE	N+1 Redundant Configuration			
	Power kW	Availability	MTTR (h)	MTBF (h)	Nines
	600	0.999997 %	3	880000	5 Nines
	750	0.999995 %	3	665200	5 Nines
	900	0.999995 %	3	665200	5 Nines
	1000	0.999994 %	3	534000	5 Nines
	1200	0.999994 %	3	534000	5 Nines
	1500	0.999993 %	3	446000	5 Nines
	1800	0.999992 %	3	383000	5 Nines

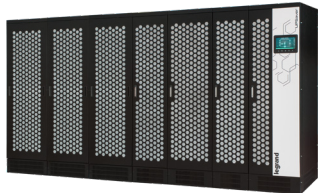

## MODULAR UPS (CONTINUED)

	UPSaver	Non-Redundant Configuration			
	Power kW	Availability	MTTR (h)	MTBF (h)	Nines
	670	0,99999907 %	2,27	2449186	6 Nines
	1000	0,99999901 %	1,84	1866674	6 Nines
	1340	0,99999895 %	1,58	1508011	5 Nines
	1670	0,99999889 %	1,40	1264961	5 Nines
	2000	0,99999883 %	1,27	1089383	5 Nines
	2340	0,99999876 %	1,18	956605	5 Nines
	2670	0,99999870 %	1,10	852678	5 Nines

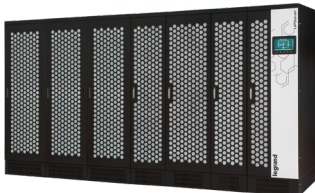



	UPSaver	N+1 Redundant Configuration			
	Power kW	Availability	MTTR (h)	MTBF (h)	Nines
	670 +1	0,99999913 %	2,14	2480149	6 Nines
	1000 +1	0,99999910 %	1,69	1893702	6 Nines
	1340 +1	0,99999907 %	1,42	1531557	6 Nines
	1670 +1	0,99999904 %	1,23	1285687	6 Nines
	2000 +1	0,99999901 %	1,09	1107839	6 Nines
	2340 +1	0,99999898 %	0,99	973215	5 Nines







## FOLLOW US ALSO ON

- @ legrand.com
-  youtube.com/user/legrand
-  facebook.com/Legrand
-  twitter.com/Legrand
-  pinterest.com/legrandgroup
-  instagram.com/legrandnews



Head office  
and International Department  
87045 Limoges Cedex - France  
Tel: + 33 (0) 5 55 06 87 87  
Fax: + 33 (0) 5 55 06 74 55